

Additional Accessories

Swivel Angle Plate

Infinitely variable adjusting of inclination with swivel angle.

Material and Color: steel, black electrophoresis

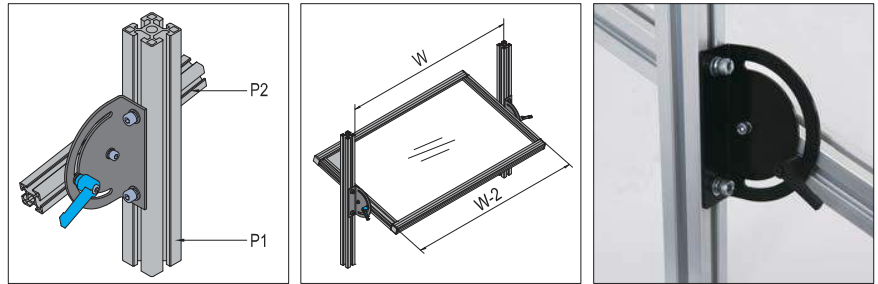

Swivel Angle Plate-PG30

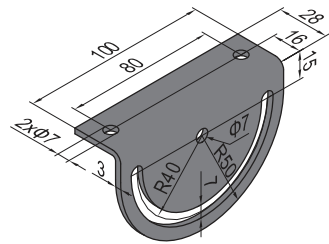

Swivel Angle Plate-PG40/45

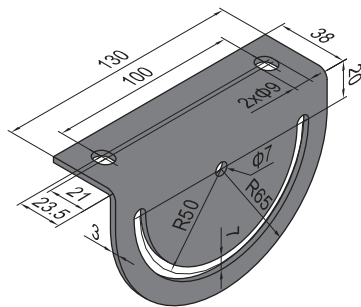

FR	FT	FV	FW	R
Fastening Set	Fastening Set	Fastening Set	Fastening Set	Fastening Set
M6x12 Adjustable Handle plastic coated, black	M6x12 Bolt zinc plated	M6x16 Bolt zinc plated	M6x16 Bolt zinc plated	M6x12 Bolt zinc plated
M6 Washer zinc plated	M6 Washer zinc plated	M6 Washer zinc plated	M6 Washer zinc plated	M6 Washer zinc plated
M6 Pre-set Nut nickel plated	M6 Pre-set Nut nickel plated	M6 T Nut nickel plated	M6 Pre-set Nut nickel plated	M6 T Nut nickel plated

Description	P1	P2	Fastening Set	Mass (g)	Part No.
Swivel Angle Plate-PG30 (pcs)				160	8.21.30
Swivel Angle Plate-PG30 (set)	PG30	PG30	1xFR+1xFT+2xR	270	8.21.30.ST
Swivel Angle Plate-PG40/45 (pcs)				288	8.21.40
Swivel Angle Plate-PG40/45-PG30 (set)	PG40/45	PG30	1xFR+1xFT+2xFV	420	8.21.40.30.ST
Swivel Angle Plate-PG40/45-PG40/45 (set)	PG40/45	PG40/45	1xFR+2xFV+1xFW	443	8.21.40.40.ST

